

版本	修改记录	修改者	修改日期
A	初始发行	GLP	2022. 4. 19

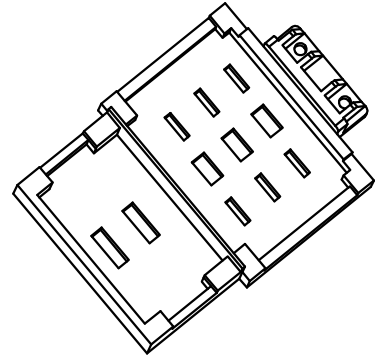

SECTION A-A

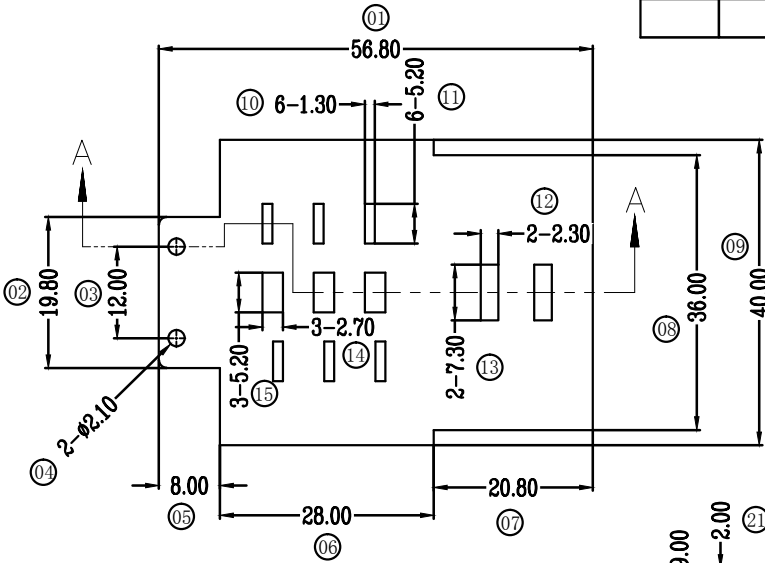
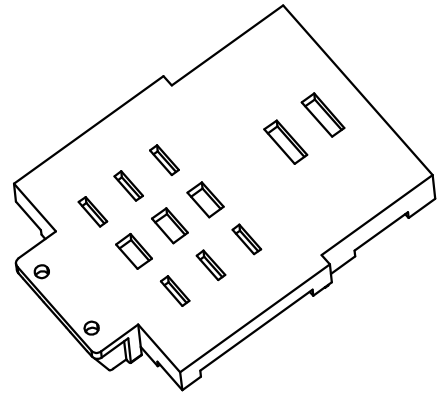
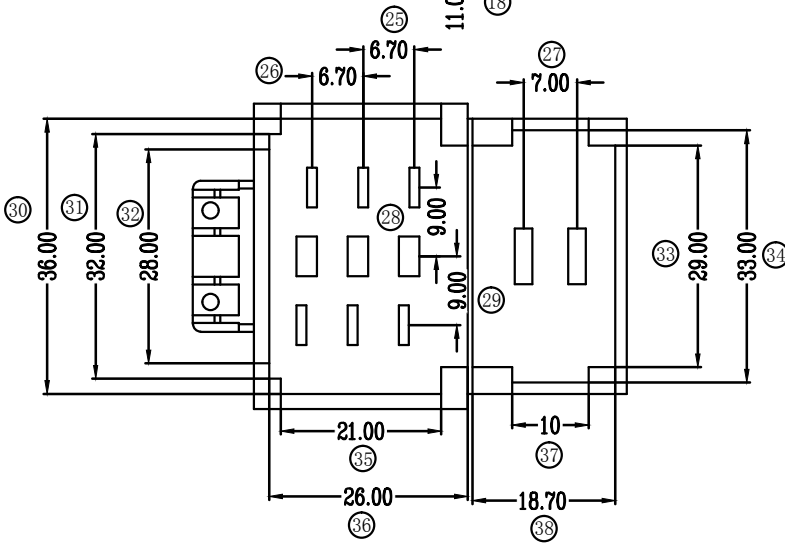
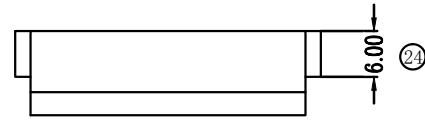
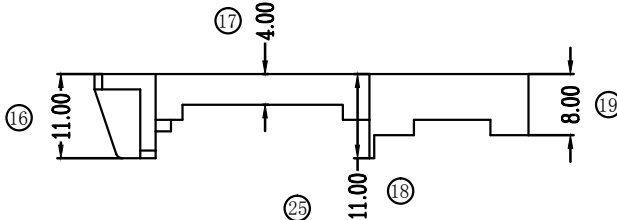
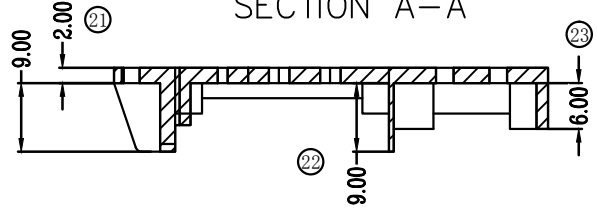

MX 东莞市铭兴电子有限公司
DONG GUAN MING XING ELECTRONICS CO., LTD
TEL: 0769-86369622 86011822 FAX: 0769-86369611

TITLE: JCL4036-220331

DRAWING NO: MX-YB340

MATERIAL: PM-9750

DWN:

TOLERANCES

CHKD:

0<L<4 ±0.1
4<L<16 ±0.2
16<L<63 ±0.3
ANGLE: ±0.5°
Wall thickness: ±0.05
PIN PITCH ±0.20

SCALE: 1/1

PIN TENSION LOAD: ---

TERMINAL MAT: ---

APPD:

UNIT: MM

UL REC. UL 94V-0

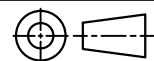

REV. A

A

B

C

D

E

F

G

7

6

5

4

3

2

1

Autodesk

Autodesk