

版本	修改记录	修改者	修改日期
A	初始发行	SAM	2022.4.13

SECTION A-A

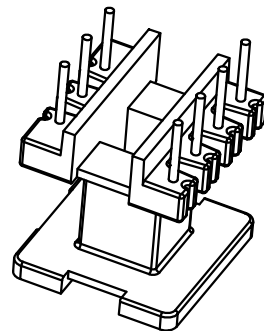
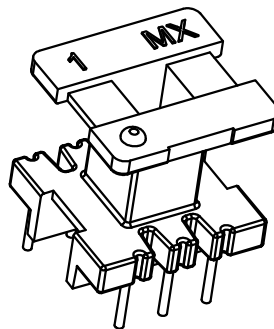
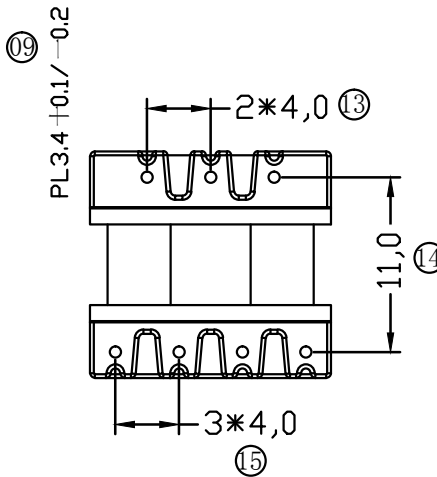
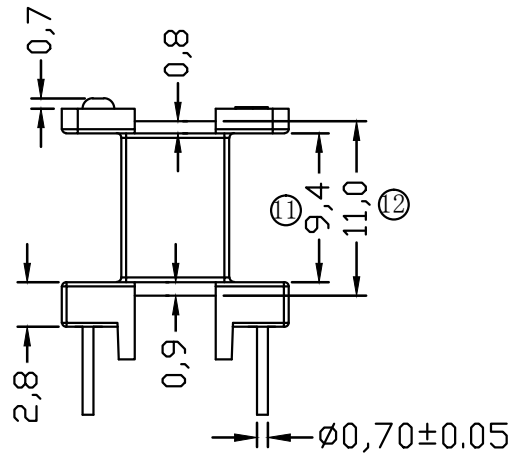
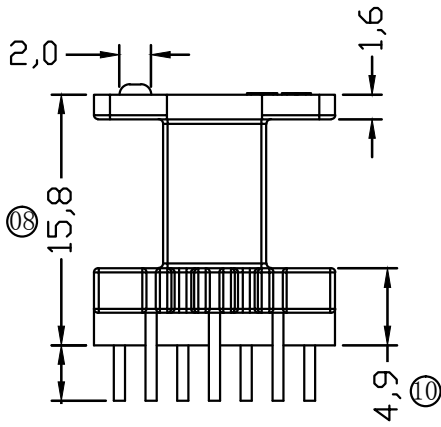
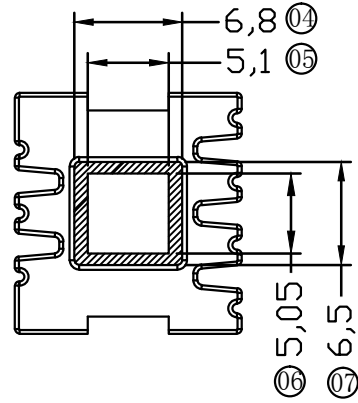
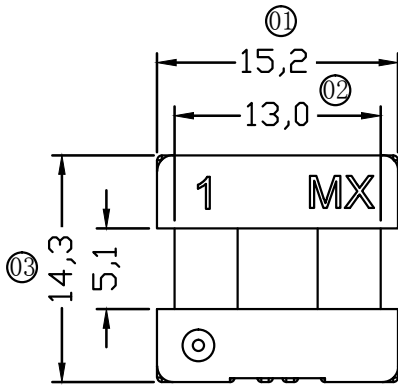

MX 东莞市铭兴电子有限公司
DONG GUAN MING XING ELECTRONICS CO., LTD

TEL: 0769-86369622 86011822 FAX: 0769-86369611

TITLE:
EE19-21 BOBBIN

DRAWING NO:
MX-1956

MATERIAL:
PHENOLIC

DWN:	TOLERANCES	
CHKD:	0<L<4 ±0.1 4<L<16 ±0.2 16<L<63 ±0.3 ANGLE: ±0.5°	Wall thickness: ±0.05 PIN PITCH ±0.2
APPD:		

SCALE: 1/1

PIN TENSION LOAD:
1.0KG

TERMINAL MAT:
CP WIRE

UNIT: MM

UL REC.
UL 94V-0

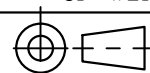

REV.
A